

# 42" Multi PDP Display

---







## **Owner's Instructions**

Before operating the unit, please read this manual thoroughly,  
and retain it for future reference."

# WARNING / CAUTION

- Please read these safety precautions carefully before using the product.
- In this manual, the illustration may be somewhat different from your product because it is just example to help the instruction.

	<b>WARNING / CAUTION</b> RISK OF ELECTRIC SHOCK DO NOT OPEN	
<p>TO REDUCE THE RISK OF ELECTRIC SHOCK DO NOT REMOVE COVER (OR BACK). NO USER SERVICEABLE PARTS INSIDE. REFER TO QUALIFIED SERVICE PERSONNEL.</p>		
 <p>The lightning flash with arrowhead symbol, within an equilateral triangle, is intended to alert the user to the presence of uninsulated “dangerous voltage” within the product’s enclosure that may be of sufficient magnitude to constitute a risk of electric shock to persons.</p>	 <p>The exclamation point within an equilateral triangle is intended to alert the user to the presence of important operating and maintenance (servicing) instructions in the literature accompanying the appliance.</p>	
<p><b>WARNING/CAUTION</b> TO REDUCE THE RISK OF FIRE AND ELECTRIC SHOCK. DO NOT EXPOSE THIS PRODUCT TO RAIN OR MOISTURE.</p>		

Read these instructions.  
 Keep these instructions.  
 Heed all warnings.  
 Follow all instructions.

- Do not block any ventilation openings. Install in accordance with the manufacturer’s instructions.

- Do not use this apparatus near water.

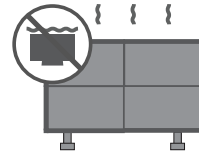
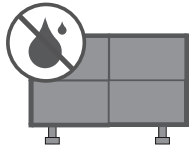

- Clean only with dry cloth.

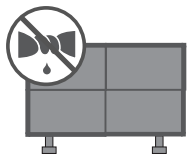

- Do not install near any heat sources such as radiators, heat registers, stoves, or other apparatus (including amplifiers) that produce heat.

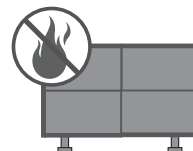

- Do not defeat the safety purpose of the polarized or grounding-type plug. A polarized plug has two blades with one wider than the other. A grounding type plug has two blades and a third grounding prong. The wide blade or the third prong are provided for your safety. If the provided plug does not fit into your outlet, consult an electrician for replacement of the obsolete outlet.

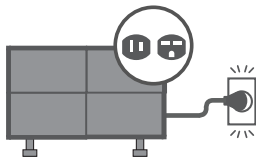

- Protect the power cord from being walked on or pinched particularly at plugs, convenience receptacles, and the point where they exit from the apparatus.

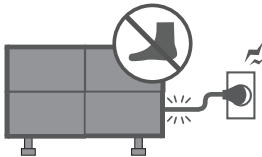

- Only use attachments/accessories specified by the manufacturer.

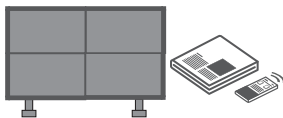

- Use only with a cart, stand, tripod, bracket, or table specified by the manufacturer, or sold with the apparatus. When a cart is used, use caution when moving the cart/apparatus combination to avoid injury from tip-over.



S3125A

- Unplug this apparatus during lightning storms or when unused for long periods of time.

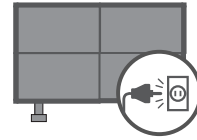

- Refer all servicing to qualified service personnel. Servicing is required when the apparatus has been damaged in any way, such as power-supply cord or plug is damaged, liquid has been spilled or objects have fallen into the apparatus, the apparatus has been exposed to rain or moisture, does not operate normally, or has been dropped.

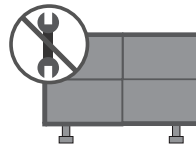

- Never touch this apparatus or antenna during a thunder or lightning storm.
- When mounting a monitor on the wall, make sure not to install the monitor by the hanging power and signal cables on the back of the monitor.
- Do not allow an impact shock or any objects to fall into the product, and do not drop onto the screen with something.

- CAUTION concerning the Power Cord:** It is recommend that appliances be placed upon a dedicated circuit; that is, a single outlet circuit which powers only that appliance and has no additional outlets or branch circuits. Check the specification page of this owner's manual to be certain. Do not connect too many appliances to the same AC power outlet as this could result in fire or electric shock. Do not overload wall outlets. Overloaded wall outlets, loose or damaged wall outlets, extension cords, frayed power cords, or damaged or cracked wire insulation are dan-

gerous . Any of these conditions could result in electric shock or fire. Periodically examine the cord of your appliance, and if its appearance indicates damage or deterioration, unplug it, discontinue use of the appliance, and have the cord replaced with an exact replacement part by an authorized servicer. Protect the power cord from physical or mechanical abuse, such as being twisted, kinked, pinched, closed in a door, or walked upon. Pay particular attention to plugs, wall outlets, and the point where the cord exits the appliance.

Do not make the monitor with the power cord plugged in. Do not use a damaged or loose power cord. Be sure do grasp the plug when unplugging the power cord. Do not pull on the power cord to unplug the monitor.

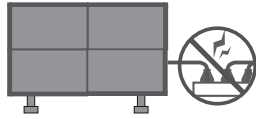

- **WARNING** - To reduce the risk of fire or electrical shock, do not expose this product to rain, moisture or other liquids. Do not touch the monitor with wet hands. Do not install this product near flammable objects such as gasoline or candles or expose the monitor to direct air conditioning.

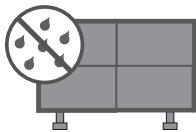

- Do not expose to dripping or splashing and do not place objects filled with liquids, such as vases, cups, etc. on or over the apparatus (e.g. on shelves above the unit).

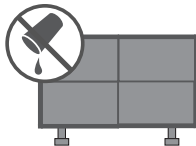

- **GROUNDING**

Ensure that you connect the earth ground wire to prevent possible electric shock (i.e. a monitor with a three-prong grounded AC plug must be connected to a three-prong grounded AC outlet). If grounding methods are not possible, have a qualified electrician install a separate circuit breaker.

Do not try to ground the unit by connecting it to telephone wires, lightening rods, or gas pipes.

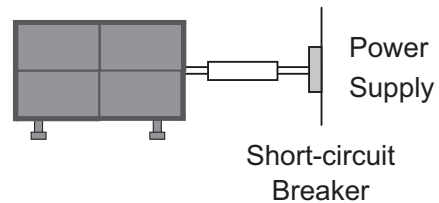

- **DISCONNECTING DEVICE FROM MAIN Power**

The power outlet must remain readily accessed in the event the device needs to be unplugged.

- As long as this unit is connected to the AC wall outlet, it is not disconnected from the AC power source even if the unit is turned off.
- Do not attempt to modify this product in any way without written authorization from the manufacturer. Unauthorized modification could void the user's authority to operate this product.

- **Cleaning**

When cleaning, unplug the power cord and scrub gently with a soft cloth to prevent scratching. Do not spray water or other liquids directly on the monitor as electric shock may occur. Do not clean with chemicals such as alcohol, thinners or benzene.

- **Moving**

Make sure the product is turned off, unplugged and all cables have been removed. It may take 2 or more people to carry larger monitors. Do not press against or put stress on the front panel of the monitor.

- **Ventilation**

Install your monitor where there is proper ventilation. Do not install in a confined space such as a bookcase. Do not cover the product with cloth or other materials (e.g.) plastic while plugged in. Do not install in excessively dusty places.

- Take care not to touch the ventilation openings. When watching the monitor for a long period, the ventilation openings may become hot.
- If you smell smoke or other odors coming from the monitor or hear strange sounds, unplug the power cord contact an authorized service center.
- When touching the monitor, use the pen provided. Do not use other sharp or pointed objects, such as your fingernail, a pen or a pencil etc.

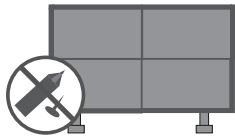

- Keep the product away from direct sunlight.
- Do not allow a impact shock or any objects to fall into the product, and do not drop onto the screen with something. You may be injured or the product can be damaged. A protection device is required for the set where shocks from the outside may occur.

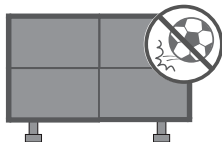

- The product should be installed where its weight can be supported. If the surface of the area where the product is installed is weak, the product may fall causing personal injury.
- Do not hang on the product or apply shock to the product. The product may fall causing personal injury.
- Install the product on a flat floor. If not (e.g., stairway and slope), the product may lose its balance and fall causing personal injury or damage to product.

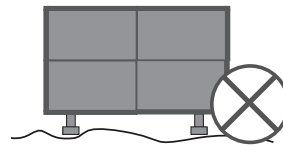

- Disconnect the plug from the outlet before installation. Otherwise, it may cause an electric shock or fire.
- Wear working gloves when installing the product. Otherwise, it may cause personal injury.

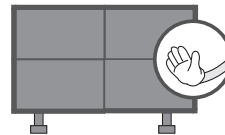

The edges of the product are sharp. Be careful not to be injured by the edges during or after installation.

- **Operating**  
Do not use sticking image over one hour to avoid 'burn-in'.  
  
Image sticking is not included in the warranty. Recommendation is to switch the sticking image within one hour to other image. (After four hour, white washing for an hour is highly recommended)

# TABLE OF CONTENTS

## 2 WARNING / CAUTION

---

## 7 ASSEMBLING AND PREPARING

---

- 7 Unpacking
- 8 Back panel information
- 9 Transportation method for panel protection
- 10 Protect the Panel when Storing
  - 10 - Correct method
  - 10 - Incorrect method
- 12 Protection cushion attachment
- 12 Allow Adequate Ventilation
- 13 Attaching the Guide Spacers
- 14 Cautions on installation
  - 14 - Stand type
  - 14 - Wall-mount type
- 15 Video and Control Connector
- 16 Brightness Adjustment Connector
- 17 Dip switch setting
- 18 IR Receiver

## 20 MAKING CONNECTIONS

---

- 20 RGB input
- 20 DP input
- 21 HDMI input
- 21 DVI input
- 22 AV input

## 23 REMOTE CONTROL

---

## 25 INITIALIZING SETUP

---

## 25 WATCHING MULTIVISION

---

- 25 - Using the input list

## 26 CUSTOMIZING MONITOR SETTINGS

---

- 26 The SETUP Menu
- 27 - PICTURE Settings
- 30 - OPTION Settings
- 32 - NETWORK Settings

## 33 TROUBLESHOOTING

---

## 35 ENVIRONMENT CONDITION

---

## 36 MULTI-OUTLET POWER STRIP SPECIFICATIONS

---

## 38 IR CODES

---

## 39 EXTERNAL CONTROL DEVICE SETUP

---

- 39 RS-232C Setup
  - 39 Type of connector;
    - D-Sub 9-Pin Male
  - 40 RS-232C Configurations
  - 41 Communication Parameters
  - 41 Command reference list
  - 42 Transmission / Receiving Protocol

# ASSEMBLING AND PREPARING

## Unpacking

Check your product box for the following items. If there are any missing accessories, contact the local dealer where you purchased your product.

The illustrations in this manual may differ from the actual product and item.

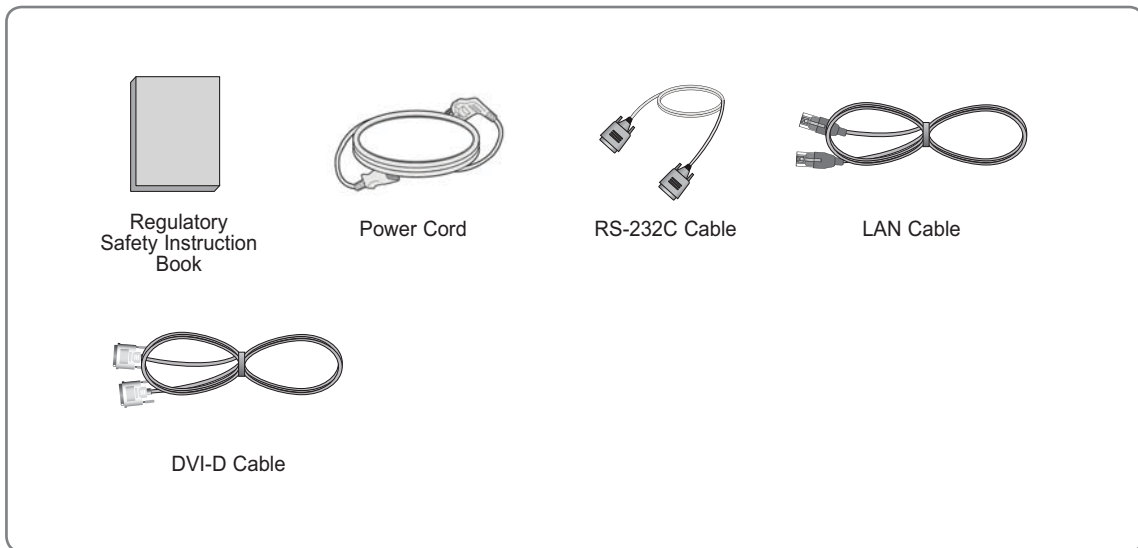

This is a class A product. In a domestic environment this product may cause radio interference, in which case the user may be required to take adequate measures.



### CAUTION

- Do not use any unapproved parts or accessories to ensure the safety and product life span.
- Any damages or injuries by using unapproved parts or accessories items are not covered by the manufacturer's warranty.

## Back panel information

- Image shown may differ from your monitor.

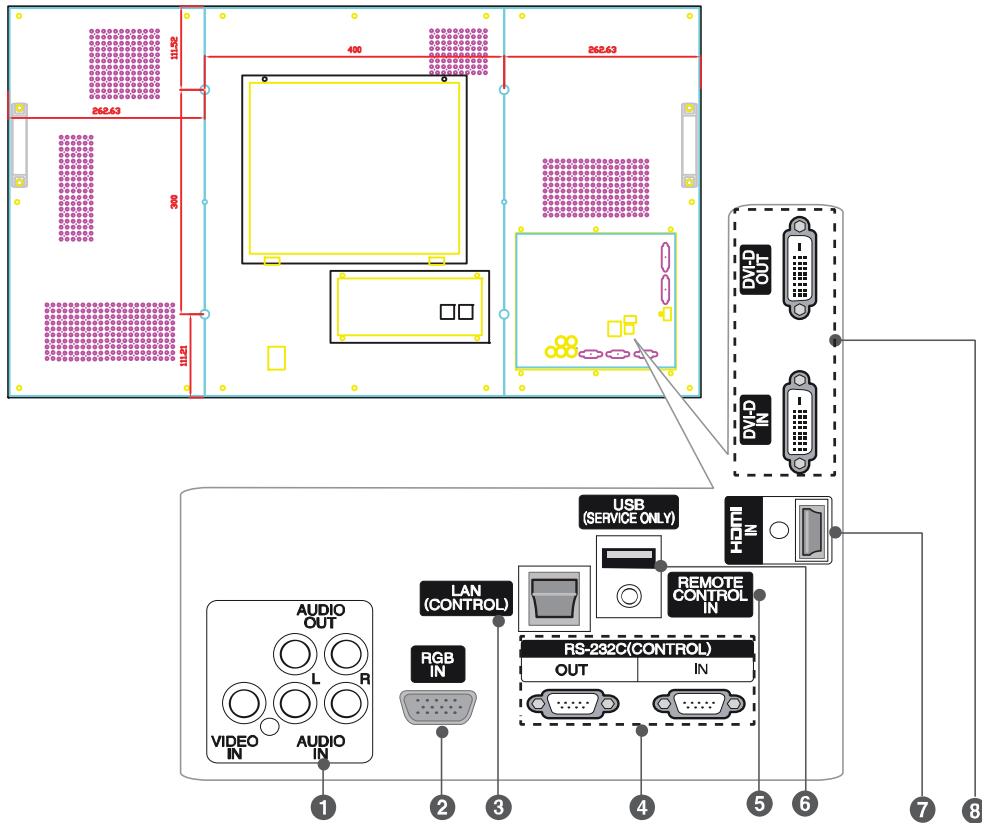

- 1 AV input**  
Connect a AV device to these jacks.
- 2 RGB INPUT**  
Connect the set output connector from a PC to the appropriate input port.
- 3 LAN (CONTROL)**  
To control the monitor via LAN cable.  
To download the firmware.
- 4 RS-232C INPUT(CONTROL&SERVICE) PORT OUT**  
To control the another set, connect a RS-232C Cable from RS-232C out port to another set's RS-232C input port.
- 5 REMOTE CONTROL IN**  
For a wired IR Receiver.
- 6 USB Input (For service)**  
Used for software updates.
- 7 HDMI IN**  
Connect an HDMI signal to HDMI.
- 8 DVI OUT, IN**  
DVI (VIDEO) signal to DVI port with DVI cable.



## Transportation method for panel protection

When moving or lifting the monitor, read the following to prevent the monitor from being scratched or damaged and for safe transportation regardless of its type and size.

### CAUTION

- Avoid touching the screen at all times, as this may result in damage on the screen.
  - Use the handles on the monitor to lift it.
- It is recommended to move the monitor in the box or packing material that the monitor originally came in.
  - Before moving or lifting the monitor, disconnect the power cord and all cables.
  - Hold firmly the handles and the bottom frame.

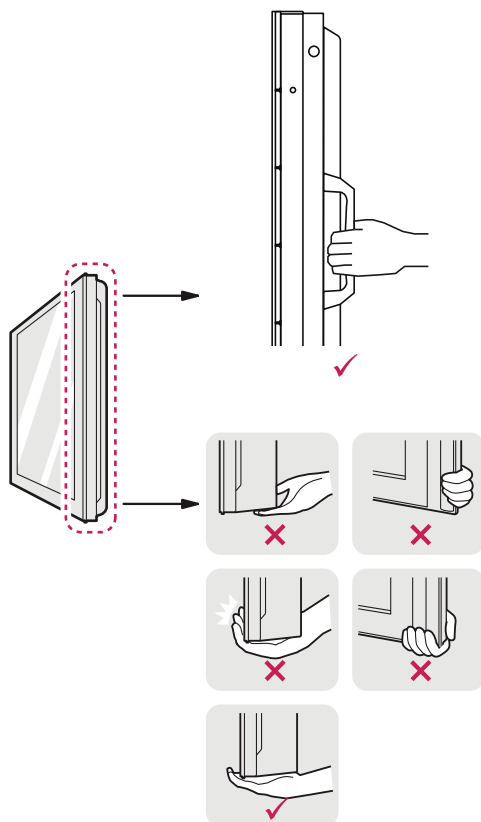

- When transporting the monitor, do not subject the monitor to jolts or excessive vibration.
- When transporting the monitor, keep the monitor upright, never turn the monitor on its side or tilt towards the left or right.
- When transporting the monitor by hand, hold the monitor as shown in the following illustration.
- When the product is carried upright, two persons should hold each handle on the top and the bottom corner. Put it down carefully and do not touch the panel.

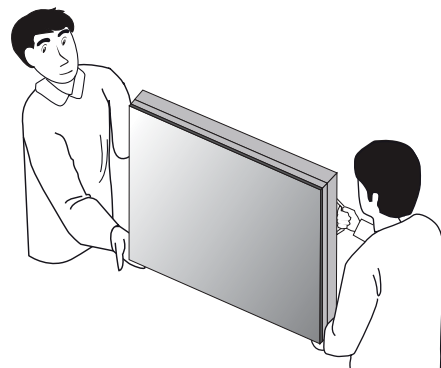

- When carrying horizontally, carry it face up with your hands on the back of the monitor. Put it down carefully and do not touch the panel.

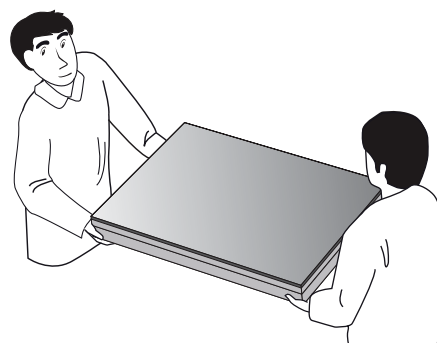

## Protect the Panel when Storing

### Correct method

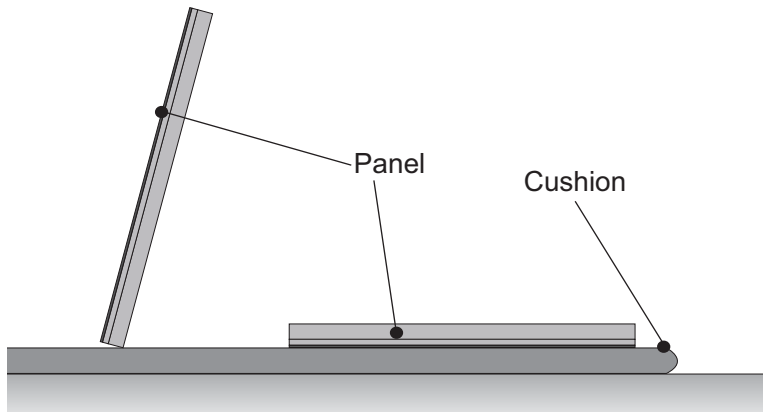

If the product needs to be set upright, hold both sides of the product, and tilt backward carefully. Do not let the panel touch the floor.

When laying down the product, lay a cushion on a flat floor, and put the product on it with the panel of the product facing down.

### Incorrect method

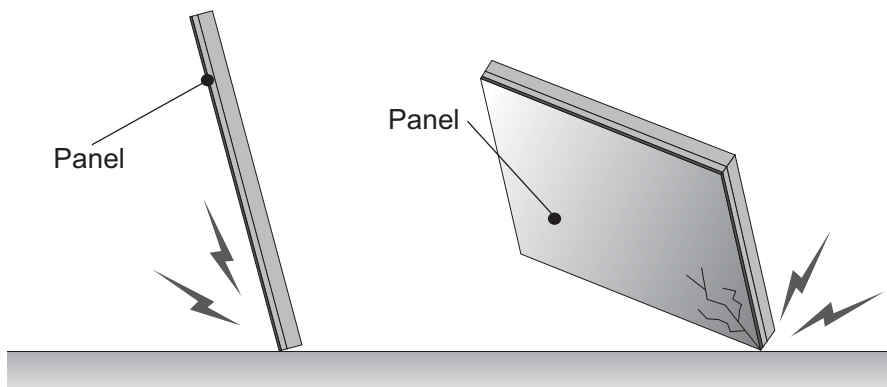

If the product is tilted on the side of the panel, the bottom of the panel may be damaged.

If the product is tilted on the edge of the panel, the edge of the panel may be damaged.

### NOTE

- Handle the product with care. The product may be damaged by shocks.

## Landscape type back

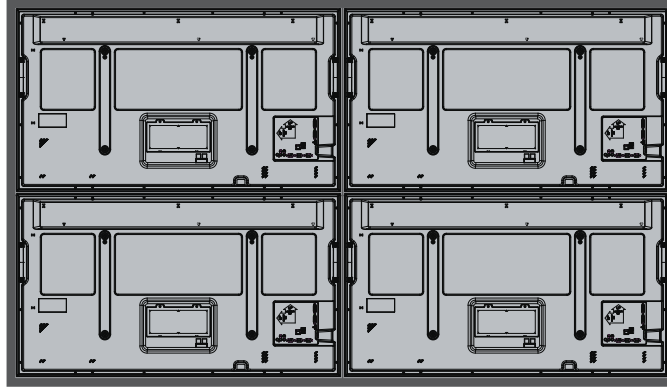

minimum : 1x1    maximum : 11x11

## Portrait type back

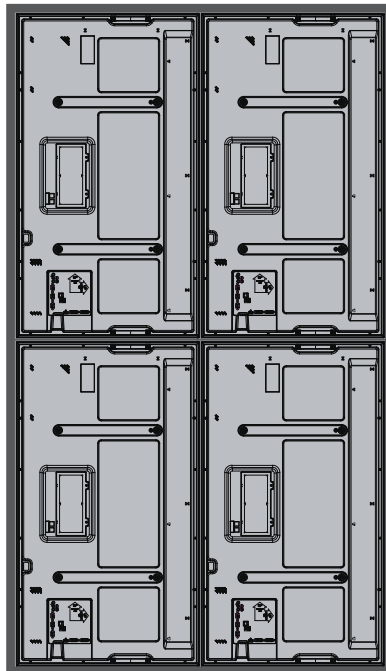

minimum : 1x1    maximum : 11x11



### NOTE

- In portrait type, the monitors must be installed so that the input ports are on the bottom.

## Protection cushion attachment

- We recommend that you attach the protection cushions, as shown in the picture below, to prevent damage.

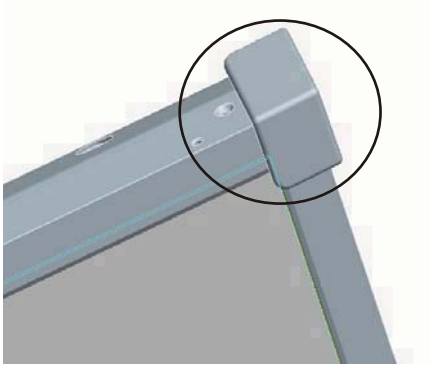
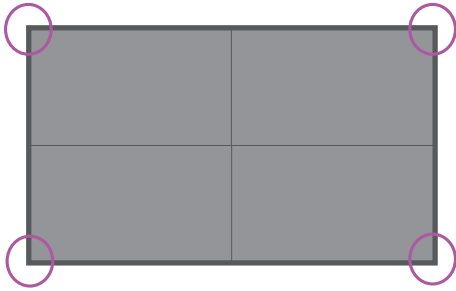

### NOTE

- It is recommended that you attach a separate frame to the edge of the set to prevent damage.

## Allow Adequate Ventilation

- Image shown may differ from your monitor.

For adequate ventilation and maintenance service, secure a minimum distance of 20 cm as shown below before installation.

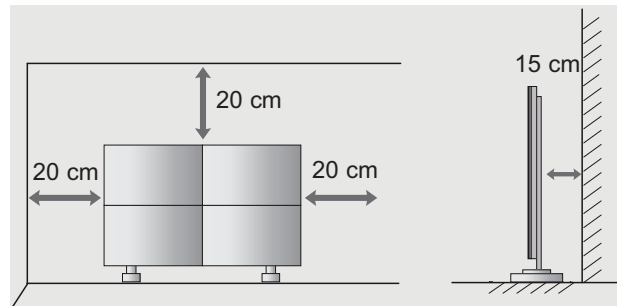

### CAUTION

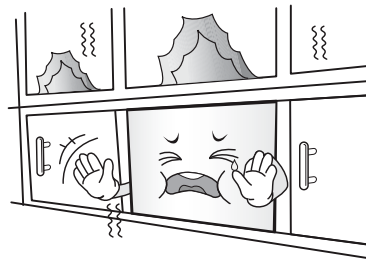

- When sets are built in to a wall, the internal temperature may rise to such an extent that it causes overheating, which may lead to a fire. To prevent the set from overheating, please follow the instructions below.
- Avoid a completely sealed installation.
- To ensure adequate ventilation, keep the top, the bottom and the sides of the set a minimum of 20 cm from the wall. (The back of the set should be a minimum of 15 cm from the wall.)
- If there is not enough space, a separate ventilation device is required.
- If you install four or more sets on top of one another, you will need to ensure a ventilator is used. (for example, a forced draft fan.)

## Attaching the Guide Spacers

If the screws are not fully tightened when you attach the guide spacers, check the length of the screws and refer to the technical service manual.

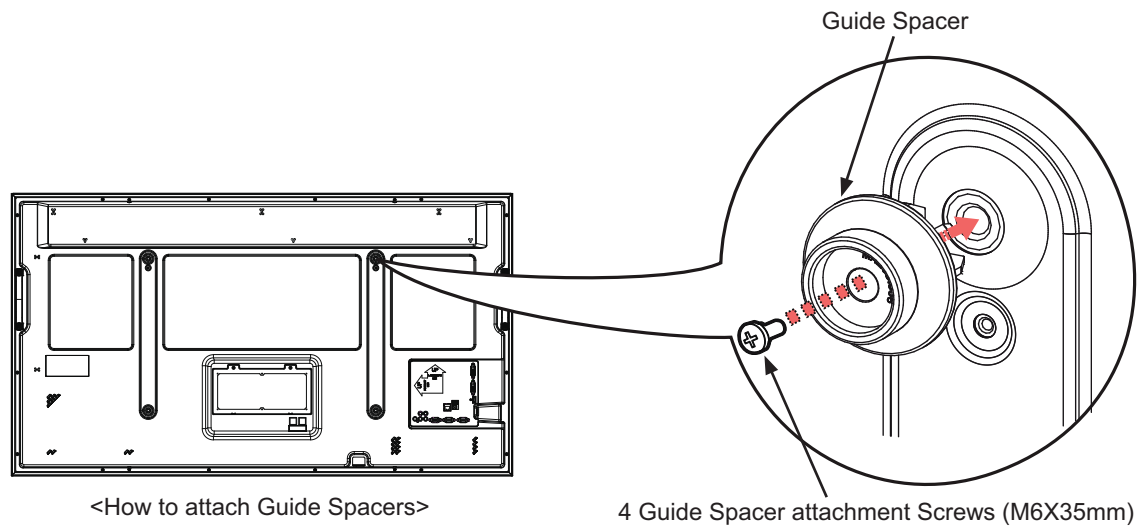

Attach the guide spacers and the guide spacer attach screws in the order shown in the picture.

Lay the set down and attach the guide spacers to the set using the screws.

- Place the product on a table with its screen facing downward. Make sure that you place it on soft clothing or a cushion on the flat surface to protect the screen.
- Tighten the screw until the monitor, the guide spacer and the screw are joined together securely.
- Use a Philips driver (manual or electric) to tighten the screws.

## Cautions on installation

### Stand type

- Do not install the product in a location where vibration or shock is likely to occur. Objects may be dropped on the product causing damage to it.
- Do not install the product next to a sprinkler sensor. The sprinkler may operate accidentally because of the heat from the product.
- Do not install the product near high-tension wires. The image on the screen may not be properly displayed.
- Do not install the product near a heater. This may cause product malfunction.

### Wall-mount type

- Check whether the wall is stable enough to install the product. If the wall is weak, it may cause an accident. Reinforce the wall before installation.
- Secure enough space for cabling before finishing the wall mounting process.

#### ! NOTE

- Lower the monitors slowly during installation to avoid panel damage by bumping into each other.

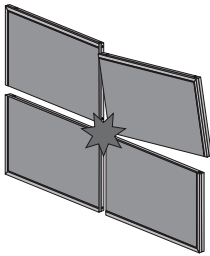

- When adjusting the interval between the monitors, make sure that the monitors are balanced vertically and horizontally. If the set is tilted as shown in the figure, this may cause damage to the product due to interference between the edges.

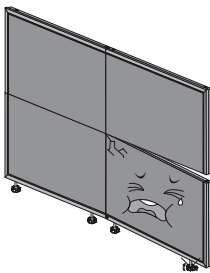

## Video and Control Connector

Use this feature to input the same video or control signals into all products.

- To use panels together, link one end of the cable to the OUT connector of one panel, and the other end to the IN connector of another panel.

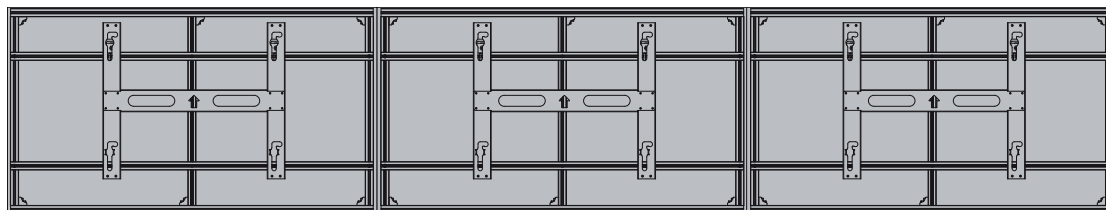

BACK PANEL

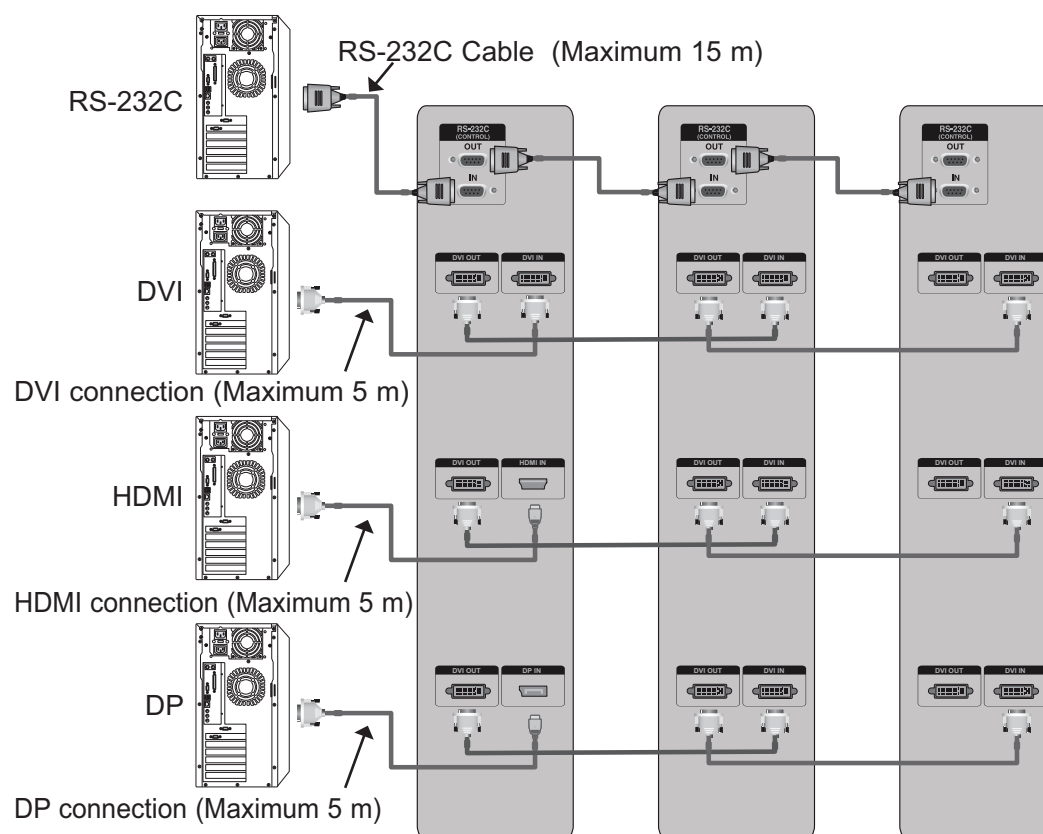

### NOTE

- If you need longer connection, please use DVI boosters or DVI fiber-optic cable.
- The maximum length of the cable from the video equipment to the panel is 5 m (DVI, HDMI, DP).
- Up to nine DVI connections are supported. (For more than 9 monitors, we recommended that you use a distributor.)
- For RS232C, up to 16 connections are supported.

## Brightness Adjustment Connector

It is a connector to compensate the luminance difference, and connect it using the LAN Cable inside the Accessory box.

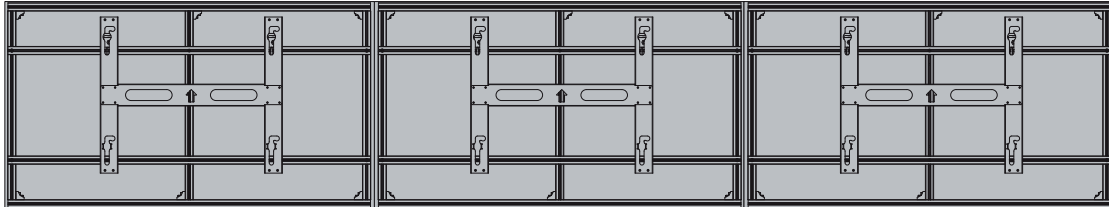

BACK PANEL

Connect LAN Cable to TX, and connect to RX connector of other sets.

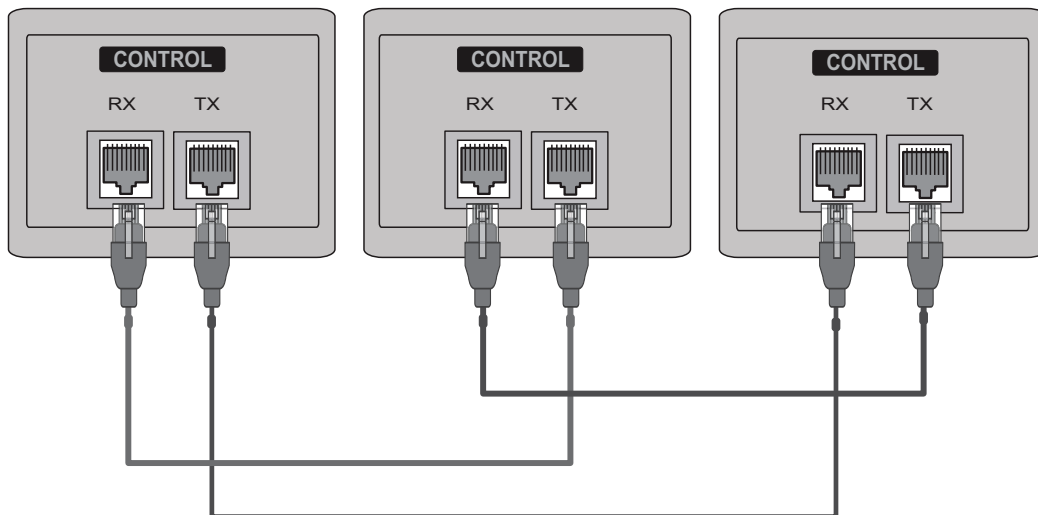



## Dip switch setting

To control each monitor separately, set a monitor ID using the dip switch.

The far left monitor becomes #1 when you stand in front of the monitors. Number the monitors in sequence from the far left to right.



- 1 Open the cover at the marked position on the back of each monitor.



- 2 Start setting up from #0 switch as shown in the figure below.

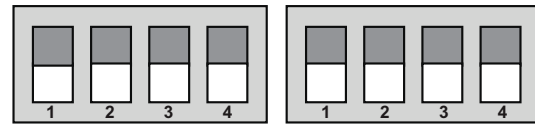
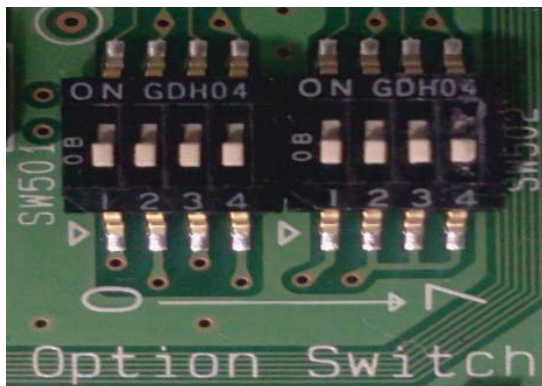

Factory reset

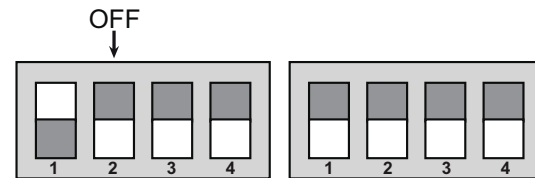

monitor #1

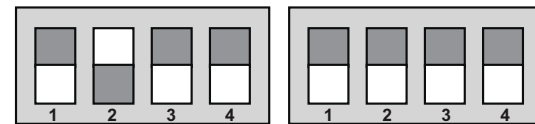

monitor #2

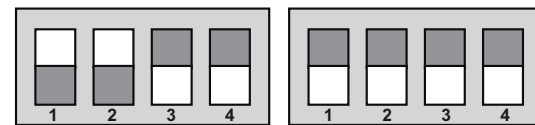

monitor #3

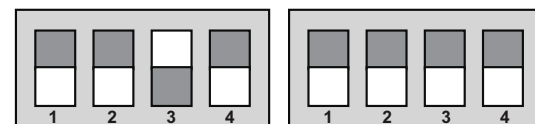

monitor #4

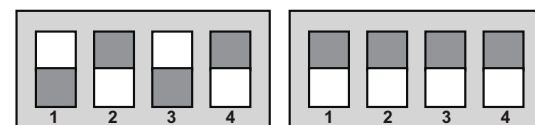

monitor #5

## IR Receiver

This will convert a IR signal to a RS-232C signal. The IR signal is set to the first monitor as IR. It is then converted and sent to all of the monitors via RS-232C.

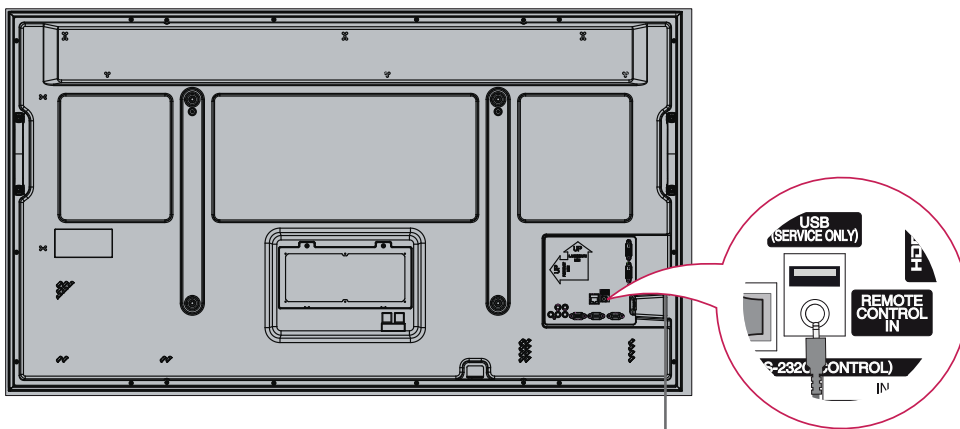
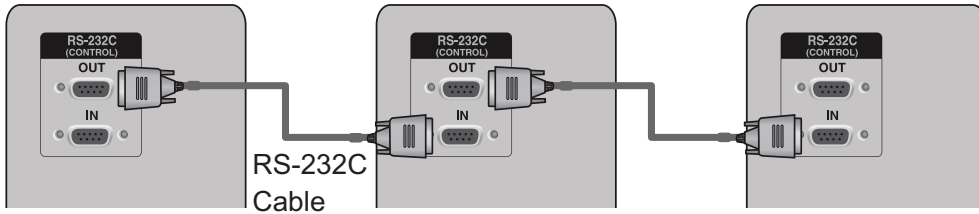

Front

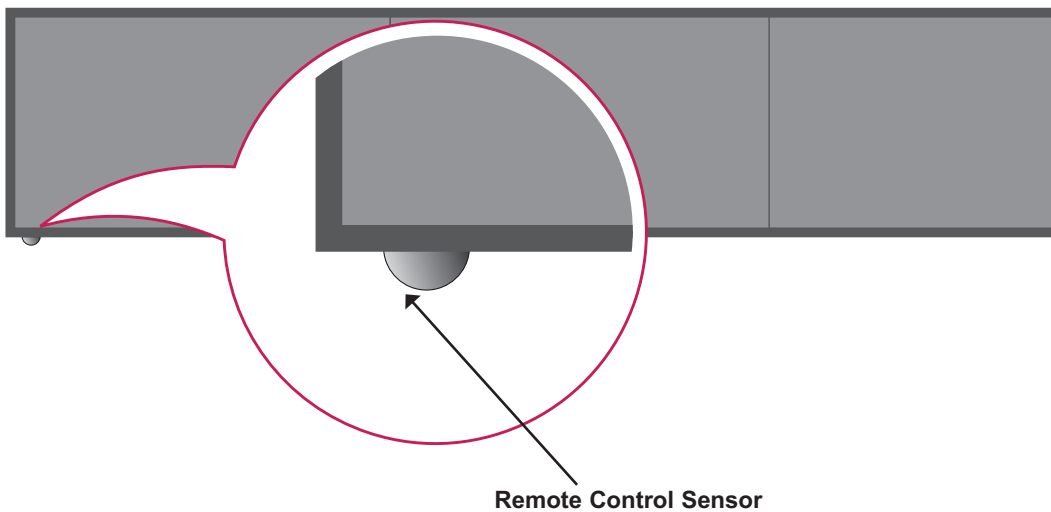

Side

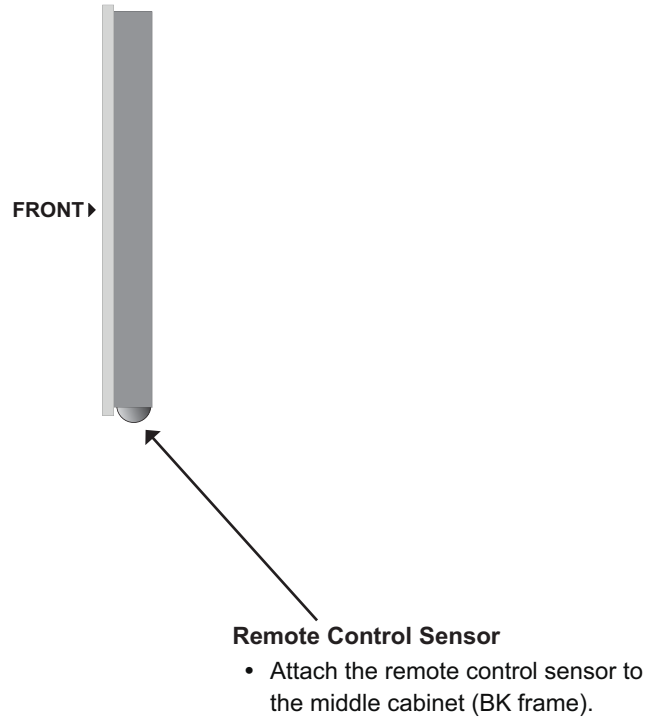

## MAKING CONNECTIONS

- Image shown may differ from your monitor.

### RGB input

- 1 Connect the RGB output of the PC to the **RGB IN** jack on the monitor.
- 2 Turn on the PC and the monitor.
- 3 Select an input signal. Press the **INPUT** button on the remote control to select the input signal.

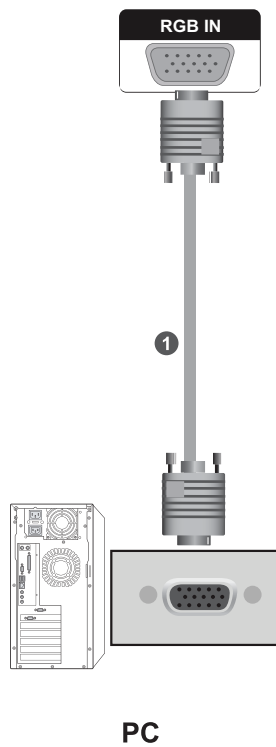
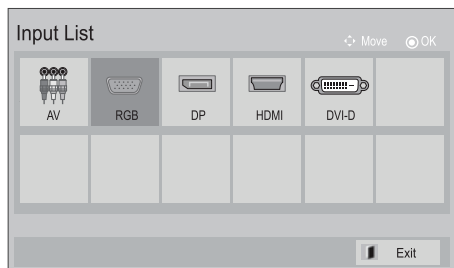

## HDMI input

- 1 Connect the HDMI output of the external equipment (digital set-top box, DVD, etc.) to **HDMI** jack on the monitor.
- 2 Turn on the external equipment. (Refer to the external equipment's manual for operating instructions.)
- 3 Select an input signal. Press the **INPUT** button on the remote control to select the input signal. **(HDMI)**

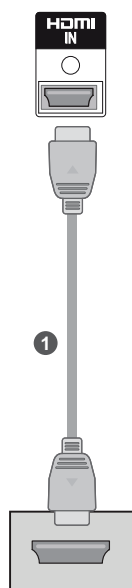
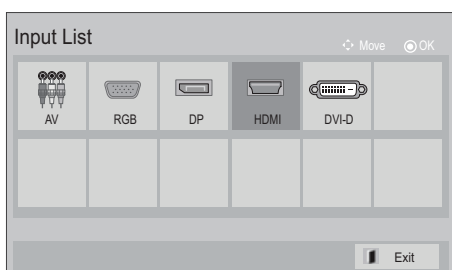

external equipment

## DVI input

- 1 Connect the DVI output of the PC to the **DVI IN** jack on the monitor.
- 2 Turn on the PC and the monitor.
- 3 Select an input signal. Press the **INPUT** button on the remote control to select the input signal.

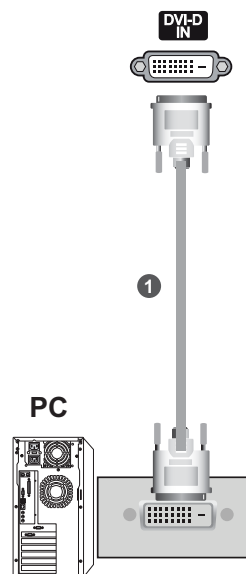
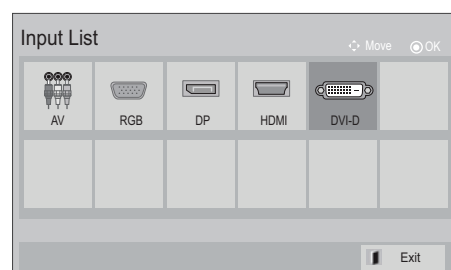

### NOTE

- It does not support HDCP(High-bandwidth Digital Content Protection) function when it is Cascade connected.
- HDCP function may not be supported for some models of third-party video distributor.

## AV input

- 1 Connect the video/audio cable as shown in the below figure and then, connect the power cord
  - Connect the input terminal with a proper color match.
- 2 Select an input signal. Press the **INPUT** button on the remote control to select the input signal.

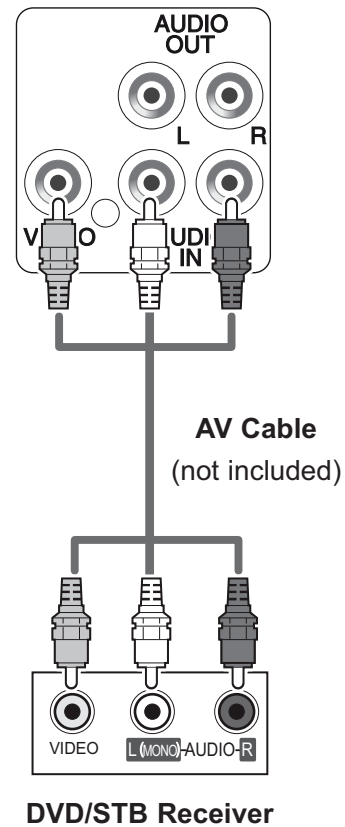
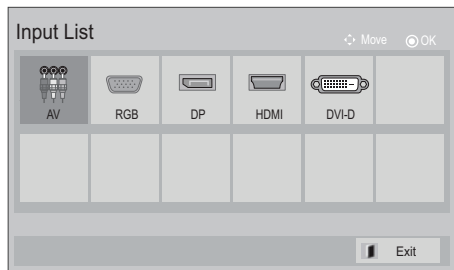

## REMOTE CONTROL

The descriptions in this manual are based on the buttons on the remote control. Please read this manual carefully and use the monitor correctly.

To replace batteries, open the battery cover, replace batteries (1.5 V AAA) matching  $\oplus$  and  $\ominus$  ends to the label inside the compartment, and close the battery cover. Be sure to point the remote control toward the remote control sensor on the monitor.

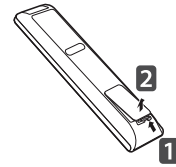

To remove the batteries, perform the installation actions in reverse.



### CAUTION

- Do not mix old and new batteries, as this may damage the remote control.

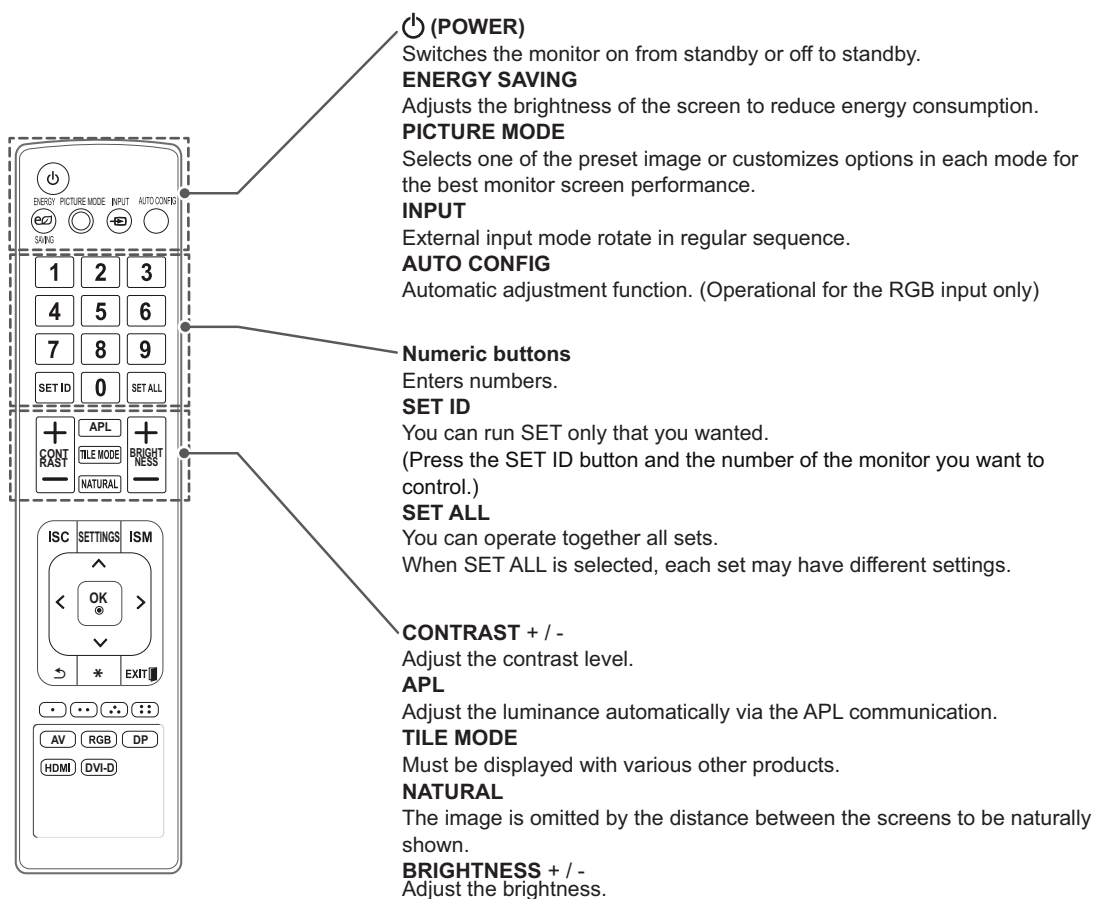

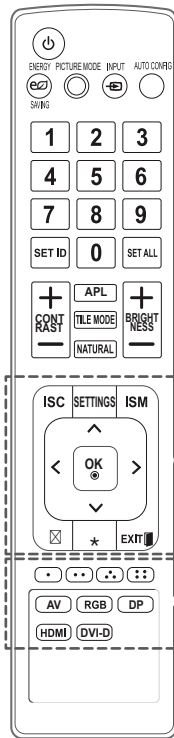
**ISC**

This function can reduce image sticking.  
(Contact your installation company for details about this function and more information on how to use it.)

**SETTINGS**

Displays on screen menus one by one.

Exits the current menu.

Memorizes menu changes.

**ISM**

Removes a ghost image on the screen.

The color block with the screen moved a little and the white pattern are alternately displayed.

**Navigation buttons** (up/down/left/right)

Allows you to navigate the on-screen menus and adjust the system settings to your preference.

**OK**

Accepts your selection or displays the current mode.

**↶ (BACK)**

Allows the user to move return one step in an interactive application

**EXIT**

Clears all on-screen displays and return to monitor viewing from any menu.

**Colored buttons**

(You can use them to run additional functions.)

**AV**

Select it when using the DVD or the Digital set-top box depends on connector.

**RGB**

Select it when using PC depends on connector.

**HDMI**

Select it when using DVD, PC or Digital set-top box depend on connector.

**DVI-D**

Select it when using PC depend on connector.



## INITIALIZING SETUP

When you turn the monitor on for the first time, the Initial setting screen appears. Select a language and customize the basic settings.

- 1 Connect the power cord to a power outlet.
- 2 In Standby mode, press **⏻ (POWER)** to turn the monitor on.  
The Initial setting screen appears if you turn the monitor on for the first time.

### NOTE

- You can also access **Factory Reset** by accessing **OPTION** in the **MENU - OPTION - Factory Reset**.

- 3 Select the language desired when the screen below appears.

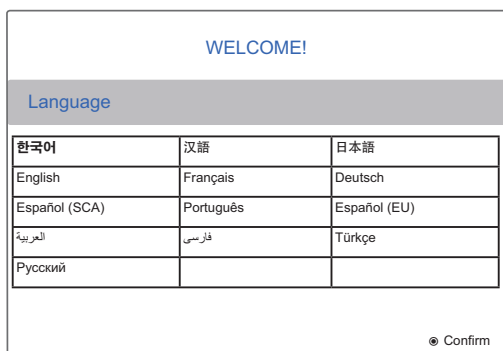

### NOTE

- If you do not complete the Initial setting, it will appear whenever the monitor turns on.
- If you time out on the OSD (On Screen Display) the installation menu will continuously appear until the set up is completed whenever the monitor is switched on.

## WATCHING MULTIVISION

### Using the input list

#### Selecting an input source

- 1 Press **INPUT** to access the input sources.
- 2 Press the Navigation buttons to scroll to one of the input sources and press **ENTER**.

- Image shown may differ from your monitor.

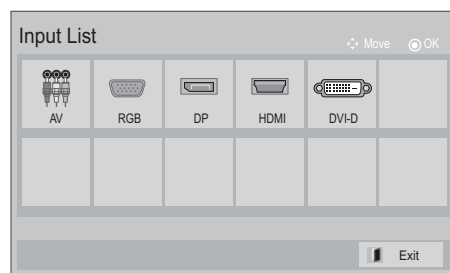

Input source	Description
<b>AV</b>	Watch video from a DVD or other external devices, or through a digital set-top box.
<b>RGB</b>	Use the monitor as a computer monitor.
<b>DP</b>	
<b>DVI-D</b>	
<b>HDMI</b>	Watch video from a HTS or other high definition devices.

# HDMI

HDMI, the HDMI logo and High-Definition Multimedia Interface are trademarks or registered trademarks of HDMI Licensing LLC.

# CUSTOMIZING MONITOR SETTINGS

## The SETUP Menu

- 1 Press **SETTINGS** to access the Home menu.
- 2 Press the Navigation buttons to scroll to one of the following menus and press **OK**.
- 3 Press the Navigation buttons to scroll to the setting or option you want and press **OK**.
- 4 When you are finished, press **EXIT**.

## PICTURE Settings

- Image shown may differ from your monitor.

- 1 Press **SETTINGS** to access the menu.
- 2 Press the Navigation buttons to scroll to **PICTURE** and press **OK**.
- 3 Press the Navigation buttons to scroll to the setting or option you want and press **OK**.
  - To return to the previous level, press **↶** (**BACK**).
- 4 When you are finished, press **EXIT**.

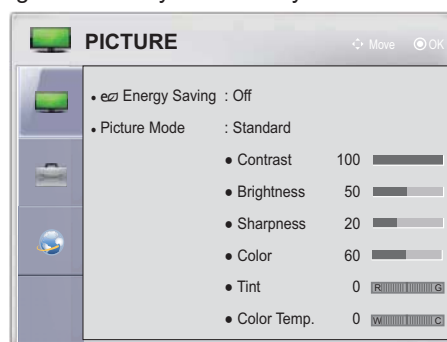

Setting	Description			
<b>Energy Saving</b>	It reduces the Monitor's power consumption. The default factory setting is adjusted to the comfortable level to be viewed at home.			
	<b>Option</b>			
	<table border="1"> <tr> <td><b>Off</b></td> <td>Energy Saving is off.</td> </tr> <tr> <td><b>On</b></td> <td>Energy Saving is on.</td> </tr> </table>	<b>Off</b>	Energy Saving is off.	<b>On</b>
<b>Off</b>	Energy Saving is off.			
<b>On</b>	Energy Saving is on.			
<b>Picture Mode</b>	Selects one of the preset image or customizes options in each mode for the best monitor screen performance. You are also able to customize advanced options of each mode. The available preset picture modes vary depending on the monitor.			
	<b>Mode</b>			
	<table border="1"> <tr> <td><b>Standard</b></td> <td>The most general screen display status.</td> </tr> <tr> <td><b>Studio</b></td> <td>Optimizes video for being used in a studio environment.</td> </tr> </table>	<b>Standard</b>	The most general screen display status.	<b>Studio</b>
<b>Standard</b>	The most general screen display status.			
<b>Studio</b>	Optimizes video for being used in a studio environment.			
<b>Aspect Ratio (only landscape type)</b>	Changes the image size to view images at its optimal size (See p.35).			
<b>SCREEN (only RGB mode)</b>	Customizes the PC display options.			
	<b>Option</b>			
	<table border="1"> <tr> <td><b>Resolution</b></td> <td>To view a normal picture, match the resolution of RGB mode and selection of PC mode.(1024x768, 1280x768, 1360x768)</td> </tr> </table>	<b>Resolution</b>	To view a normal picture, match the resolution of RGB mode and selection of PC mode.(1024x768, 1280x768, 1360x768)	
	<b>Resolution</b>	To view a normal picture, match the resolution of RGB mode and selection of PC mode.(1024x768, 1280x768, 1360x768)		
	<table border="1"> <tr> <td><b>Auto Configure</b></td> <td>This function is for automatic adjustment of the screen position, size, and phase The displayed image will be unstable for a few seconds while the auto configuration is in progress.</td> </tr> </table> <div style="border: 1px solid black; padding: 5px; margin-top: 10px;"> <p><b>!</b> <b>NOTE</b></p> <ul style="list-style-type: none"> <li>• If the position of the image is still not correct, try Auto adjustment again.</li> <li>• If picture needs to be adjusted again after Auto adjustment in RGB, you can adjust the <b>Position</b>, <b>Size</b> or <b>Phase</b>.</li> </ul> </div>	<b>Auto Configure</b>	This function is for automatic adjustment of the screen position, size, and phase The displayed image will be unstable for a few seconds while the auto configuration is in progress.	
	<b>Auto Configure</b>	This function is for automatic adjustment of the screen position, size, and phase The displayed image will be unstable for a few seconds while the auto configuration is in progress.		
	<table border="1"> <tr> <td><b>Position</b></td> <td>This function is to adjust picture to left/right and up/down as you prefer.</td> </tr> </table>	<b>Position</b>	This function is to adjust picture to left/right and up/down as you prefer.	
	<b>Position</b>	This function is to adjust picture to left/right and up/down as you prefer.		
<table border="1"> <tr> <td><b>Size</b></td> <td>This function is to minimize any vertical bars or stripes visible on the screen background. And the horizontal screen size will also change.</td> </tr> </table>	<b>Size</b>	This function is to minimize any vertical bars or stripes visible on the screen background. And the horizontal screen size will also change.		
<b>Size</b>	This function is to minimize any vertical bars or stripes visible on the screen background. And the horizontal screen size will also change.			
<table border="1"> <tr> <td><b>Phase</b></td> <td>This function allows you to remove any horizontal noise and clear or sharpen the image of characters.</td> </tr> </table>	<b>Phase</b>	This function allows you to remove any horizontal noise and clear or sharpen the image of characters.		
<b>Phase</b>	This function allows you to remove any horizontal noise and clear or sharpen the image of characters.			
<table border="1"> <tr> <td><b>Reset</b></td> <td>Returns Position, Size and Phase to the factory default settings.</td> </tr> </table>	<b>Reset</b>	Returns Position, Size and Phase to the factory default settings.		
<b>Reset</b>	Returns Position, Size and Phase to the factory default settings.			

**Basic image options**

Setting	Description
<b>Contrast</b>	Adjusts the signal level between black and white in the picture. You may use Contrast when the bright part of the picture is saturated.
<b>Brightness</b>	Adjusts the base level of the signal in the picture.
<b>Sharpness</b>	Adjusts the level of crispness in the edges between the light and dark areas of the picture. The lower the level, the softer the image.
<b>Color</b>	Adjusts intensity of all Colors.
<b>Tint</b>	Adjusts the balance between red and green levels.
<b>Color Temp.</b>	Adjust to left direction to make a picture reddish or adjust to right direction to make a picture bluish.
<b>Advanced Control</b>	You can calibrate the screen for each Picture Mode or set the video value according to the special video screen. You can set the video value differently for each input. To reset to the factory default screen after making adjustments to each video mode, execute the "Picture Reset" function for each Picture Mode.
<b>Picture Reset</b>	Settings of the selected picture modes return to the default factory settings.

**Advanced image options**

Setting	Description
<b>Dynamic Contrast</b>	Adjusts the contrast to keep it at the best level according to the brightness of the screen. The picture is improved by making bright parts brighter and dark parts darker.
<b>Noise Reduction</b>	Reduces screen noise without compromising video quality.
<b>Gamma</b>	You can adjust brightness of dark area and middle gray level area of the picture. <ul style="list-style-type: none"> <li>» Low: Make the dark and middle gray level areas brighter.</li> <li>» Medium: Express the original picture level.</li> <li>» High: Make the dark and middle gray level area darker.</li> </ul>
<b>Black Level</b>	This function enables to select 'Low' or 'High' in the following mode: HDMI or AV or DVI. <ul style="list-style-type: none"> <li>» Low: The reflection of the screen gets darker.</li> <li>» High: The reflection of the screen gets brighter.</li> </ul>

### Adjusting aspect ratio

#### ! NOTE

- You can also change the image size by accessing **Aspect Ratio** in the **PICTURE** menus.
- You can adjust the enlarge proportion using the Navigation buttons.
- When Tile Mode and OSD Pivot are set to On, only the aspect ratio of 16:9 and Just Scan are supported.

- **4:3:** This picture format is 4:3 aspect ratio.



- **16:9:** Wides screen mode.



- **Just Scan:** Allows you to enjoy the transmitted data fully without any images cut off.

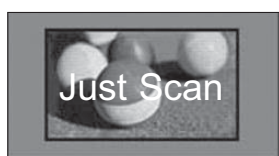

#### ! NOTE

- If there is noise in original Picture, You can see the noise at the edge.

### Supported Aspect Ratio

	AV	RGB	HDMI/DVI-D	HDMI/DVI-D
16:9	O	O	O	O
Just Scan	O	X	O	X
4:3	O	O	O	O

## OPTION Settings

- Image shown may differ from your monitor.

- 1 Press **SETTINGS** to access the menu.
- 2 Press the Navigation buttons to scroll to **OPTION** and press **OK**.
- 3 Press the Navigation buttons to scroll to the setting or option you want and press **OK**.  
- To return to the previous level, press **↶ (BACK)**.
- 4 When you are finished, press **EXIT**.

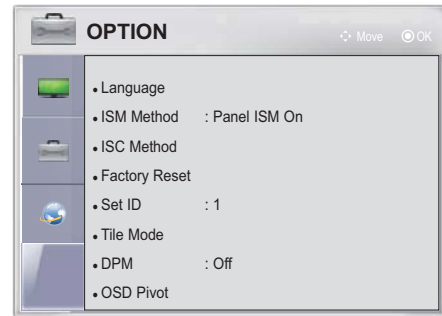

Setting	Description
<b>Language</b>	Selects a language for the display.
<b>ISM Method</b>	A frozen or still picture displayed on the screen for prolonged periods will result in a ghost image remaining even when you change the image. Avoid allowing a fixed image to remain on the screen for prolonged periods.
	<b>Mode</b>
	<b>Panel ISM Off/On</b> If image sticking is never a problem, ISM is not necessary - set to Panel ISM Off.
	<b>Color Wash</b> Removes a ghost image on the screen. The color block with the screen moved a little and the white pattern are alternately displayed. It is difficult to sense the afterimage occurred while the temporary afterimage is removed and the color pattern is operating.
	<b>White Wash</b> Removes a ghost image on the screen. White wash removes permanent images from the screen. Note: An excessive permanent image may be impossible to clear entirely with White Wash.
<b>ISC Method</b>	The ISC method reduces image sticking, which occurs when a fixed image is played for a long period of time. (Contact your installation company for details about this function and more information on how to use it.)
<b>Factory Reset</b>	This function initializes all settings. When the Factory Reset is completed, you must restart the Initializing setup.
<b>Set ID</b>	When controlling multiple monitors with the RS232C control or the remote control, each monitor can be identified with its monitor ID. Use the dip switch to set up a monitor ID during installation of a set. (See p.22)
<b>Tile Mode</b>	Tile mode choose Tile alignment and set the ID of the current product to set location.
	<b>Option</b>
	<b>Tile mode</b> 11 x 11 available. Configuration of an integration screen is also available as well as configuration of One by one Display. It is used to enlarge the screen and also used with several products to view screen.
	<b>Tile ID</b> The Tile ID determines the location of the Tile.
	<b>Auto Configuration</b> Automatically adjusts the picture position and minimizes image instability. After adjustment, if the image is still not correct, your Monitor is functioning properly but needs further adjustment. This function is for automatic adjustment of the screen position, size, and phase The displayed image will be unstable for a few seconds while the auto configuration is in progress.
	<b>Position</b> If the picture is not clear after auto adjustment and especially if characters are still trembling, adjust the picture position manually.
	<b>Size</b> This function is to minimize any vertical bars or stripes visible on the screen background. And the horizontal screen size will also change.
	<b>Natural</b> The image is omitted by the distance between the screens to be naturally shown.
	<b>Reset</b> Returns Position, Size and Phase to the factory default settings.

---

Setting	Description
<b>DPM</b>	A user can choose to turn the power saving mode on / off.
<b>OSD Pivot</b>	The OSD appears vertically. When the panels are installed vertically, set the OSD Pivot option to On.
<b>Power On Delay</b>	When connecting multiple monitors and turning the power on, the monitors are turned on at different intervals to prevent overload.

## NETWORK Settings

- Image shown may differ from your monitor.

- 1 Press **SETTINGS** to access the menu.
- 2 Press the Navigation buttons to scroll to **NETWORK** and press **OK**.
- 3 Press the Navigation buttons to scroll to the setting or option you want and press **OK**.
  - To return to the previous level, press **↶** (**BACK**).
- 4 When you are finished, press **EXIT**.

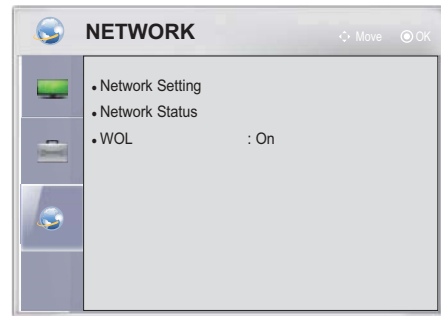

Setting	Description
<b>Network Setting</b>	Configure the network settings.
<b>Network Status</b>	Display the network status. - Internet is connected : Externally connected - Network is connected : Only internally connected - Not connected : When there is no network connection
<b>WOL (Wake-on-LAN)</b>	To turn on the TV via the network. The initial settings is OFF. Set to ON to use this feature.



# TROUBLESHOOTING

## Abnormal operation

Problem	Resolution
The remote control doesn't work	<ul style="list-style-type: none"> <li>• Check to see if there is any object between the Monitor and the remote control causing an obstruction. Ensure you are pointing the remote control directly at the Monitor.</li> <li>• Ensure that the batteries are installed with correct polarity (+ to +, - to -).</li> <li>• Install new batteries.</li> </ul>
Monitor turns off suddenly	<ul style="list-style-type: none"> <li>• Is the sleep timer set?</li> <li>• It can be turned off by DPM(Display power management). Check the DPM functions.</li> </ul>

## Video problems

Problem	Resolution
No picture	<ul style="list-style-type: none"> <li>• Check whether the product is turned on.</li> <li>• Is the power cord inserted into wall power outlet?</li> <li>• Test the wall power outlet, plug another product's power cord into the outlet where the product's power cord was plugged in.</li> </ul>
Picture appears slowly after switching on	<ul style="list-style-type: none"> <li>• This is normal, the image is muted during the product startup process. Please contact your service center, if the picture has not appeared after five minutes.</li> </ul>
No or poor color or poor picture	<ul style="list-style-type: none"> <li>• Adjust Color in menu option.</li> <li>• Keep a sufficient distance between the product and the VCR.</li> <li>• Are the video cables installed properly?</li> <li>• Activate any function to restore the brightness of the picture.</li> </ul>
Horizontal/vertical bars or picture shaking	<ul style="list-style-type: none"> <li>• Check for local interference such as an electrical appliance or power tool.</li> </ul>
No picture when connecting HDMI	<ul style="list-style-type: none"> <li>• If the HDMI cables don't support High Speed HDMI, it can cause flickers or no screen display. In this case use the latest cables that support High Speed HDMI.</li> </ul>
Brightness is significantly different from monitor to monitor.	<ul style="list-style-type: none"> <li>• Check that the dip switch of the monitor is set correctly.</li> <li>• Check that the brightness adjustment connector is working correctly.</li> </ul>

## Audio problems

Problem	Resolution
Unusual sound from inside the product	<ul style="list-style-type: none"> <li>• A change in ambient humidity or temperature may result in an unusual noise when the product is turned on or off and does not indicate a fault with the product.</li> </ul>

**PC Mode problems**

<b>Problem</b>	<b>Resolution</b>
The signal is out of range	<ul style="list-style-type: none"><li>• Adjust resolution, horizontal frequency, or vertical frequency on the PC.</li><li>• Check the input source.</li></ul>
Vertical bar or stripe on background & Horizontal Noise & Incorrect position	<ul style="list-style-type: none"><li>• Activate the Auto configure feature or adjust size, phase, or H/V position. (Option)</li></ul>
Screen color is unstable or single color	<ul style="list-style-type: none"><li>• Check the signal cable.</li><li>• Reinstall the PC video card.</li></ul>

## ENVIRONMENT CONDITION

Environment condition	Operating Temperature	0 °C to 40 °C
	Operating Humidity	Less than 80 %
	Storage Temperature	-20 °C to 60 °C
	Storage Humidity	Less than 85 %

## MULTI-OUTLET POWER STRIP SPECIFICATIONS

### Specification

- Type : Outlets with surge protector and safety ground
- Electrical Spec : 250V, 3.2A or higher per hole / 125V, 7A or higher per hole.  
Multi-outlet total wattage should be determined by considering each hole specification and the number of plugged display pieces.
- Special function : Overload blocking.

### Warnings & Recommendations

- Do not plug other electrical products or equipments into the multi-outlet that is used for this product.
- It is recommended to plug the multi-outlet power strip into the wall outlet that is considered total wattage or higher.
- It is recommended to use the multi-outlet certified by safety standards in your country.

### Safety Standard

	Mark
Japan	
China	
Taiwan	
Singapore	
Mexico	
Argentina	

Use the multi-outlet certified by safety standards in your country except for the countries mentioned above.

**RGB Input ( PC )**

	Resolution	Horizontal Frequency (kHz)	Vertical Frequency (Hz)
1	640x350	31.468	70.09
2	720x400	31.469	70.08
3	640x480	31.469	59.94
4	800x600	37.879	60.31
5	1024x768	48.363	60.00
6	1280x768	47.776	59.870
7	1360x768	47.712	60.015
8	1280x1024	63.981	60.020
9	1600x1200	75.00	60.00

**HDMI/Display Port Input (PC)**

	Resolution	Horizontal Frequency (kHz)	Vertical Frequency (Hz)
1	640x350	31.468	70.09
2	720x400	31.469	70.08
3	640x480	31.469	59.94
4	800x600	37.879	60.31
5	1024x768	48.363	60.00
6	1360x768	47.712	60.015
7	1365x768	47.71	59.79
8	1280x1024	63.981	60.02
9	1600x1200	75.00	60.00
10	1920x1080	67.5	60.00

**DVI input ( PC )**

	Resolution	Horizontal Frequency (kHz)	Vertical Frequency (Hz)
1	640x350	31.468	70.09
2	720x400	31.469	70.08
3	640x480	31.469	59.94
4	800x600	37.879	60.31
5	1024x768	48.363	60.00
6	1280x768	47.776	59.87
7	1360x768	47.712	60.015
8	1365x768	47.71	59.79
9	1280x1024	63.981	60.02
10	1600x1200	75.00	60.00
11	1920x1080	67.5	60.00

**HDMI/Display Port input(DTV)**

	Resolution	Horizontal Frequency (kHz)	Vertical Frequency (Hz)
1	720x480	15.75	60.00
2	720x480	15.73	59.94
3	720x576	15.625	50.00
4	720x480	31.47	59.94
5	720x480	31.5	60.00
6	720x576	31.25	50.00
7	1280x720	44.96	59.94
8	1280x720	45.00	60.00
9	1280x720	37.5	50.00
10	1920x1080	33.72	59.94
11	1920x1080	33.75	60.00
12	1920x1080	28.125	50.00
13	1920x1080	67.432	59.94
14	1920x1080	67.5	60.00
15	1920x1080	56.25	50.00
16	1920x1080	27.00	24.00
17	1920x1080	33.75	30.00

**DVI input ( DTV )**

	Resolution	Horizontal Frequency (kHz)	Vertical Frequency (Hz)
1	720x480	15.75	60.00
2	720x480	15.73	59.94
3	720x576	15.625	50.00
4	720x480	31.47	59.94
5	720x480	31.5	60.00
6	720x576	31.25	50.00
7	1280x720	44.96	59.94
8	1280x720	45.00	60.00
9	1280x720	37.5	50.00
10	1920x1080	33.72	59.94
11	1920x1080	33.75	60.00
12	1920x1080	28.125	50.00
13	1920x1080	67.432	59.94
14	1920x1080	67.5	60.00
15	1920x1080	56.25	50.00
16	1920x1080	27.00	24.00
17	1920x1080	33.75	30.00

## IR CODES

Code (Hexa)	Function	Note	Code (Hexa)	Function	Note
95	ENERGY SAVING	Remote control Button	5B	EXIT	Remote control Button
0B	INPUT	Remote control Button	61	Blue	Remote control Button
99	AUTO CONFIG	Remote control Button	D5	RGB	Remote control Button
10	0	Remote control Button	C6	DVI-D	Remote control Button
11	1	Remote control Button	CE	HDMI	Remote control Button
12	2	Remote control Button	08	POWER	Remote control Button
13	3	Remote control Button	72	Red	Remote control Button
14	4	Remote control Button	71	Green	Remote control Button
15	5	Remote control Button	63	Yellow	Remote control Button
16	6	Remote control Button	4D	PICTURE MODE	Remote control Button
17	7	Remote control Button	F6	CONTRAST +	Remote control Button
18	8	Remote control Button	F7	CONTRAST -	Remote control Button
19	9	Remote control Button	04	APL	Remote control Button
56	SET ID	Remote control Button	E0	BRIGHTNESS +	Remote control Button
46	SET ALL	Remote control Button	E1	BRIGHTNESS -	Remote control Button
7B	TILE MODE	Remote control Button	5A	AV	Remote control Button
87	NATURAL	Remote control Button			
C9	ISC	Remote control Button			
43	SETTINGS	Remote control Button			
83	ISM	Remote control Button			
06	> (Arrow Key)	Remote control Button			
07	< (Arrow Key)	Remote control Button			
40	^ (Arrow Key)	Remote control Button			
41	∨ (Arrow Key)	Remote control Button			
44	OK	Remote control Button			
28	BACK	Remote control Button			

## EXTERNAL CONTROL DEVICE SETUP

### RS-232C Setup

Connect the RS-232C (serial port) input jack to an external control device (such as a computer or an A/V control system) to control the product's functions externally.

Connect the serial port of the control device to the RS-232C jack on the product back panel.



#### NOTE

- RS-232C on this monitor is intended to be used with third party RS-232C control hardware and software. The instructions below are provided to help with programming software or to test functionality using telenet software.
- RS-232C connection cables are not supplied with the product.

### Type of connector; D-Sub 9-Pin Male

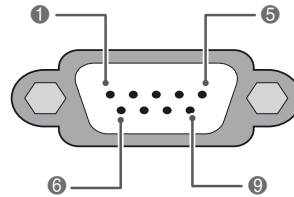

No.	Pin name
1	No connection
2	RXD (Receive data)
3	TXD (Transmit data)
4	DTR (DTE side ready)
5	GND
6	DSR (DCE side ready)
7	RTS (Ready to send)
8	CTS (Clear to send)
9	No Connection

## RS-232C Configurations

### Set ID

Set ID number. "Real Data Mapping" (See p.52)

#### 7-Wire Configurations (Standard RS-232C cable)

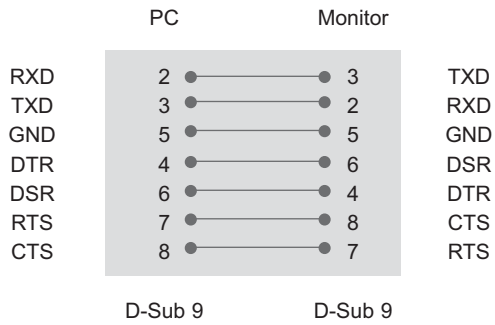

#### 3-Wire Configurations (Not standard)

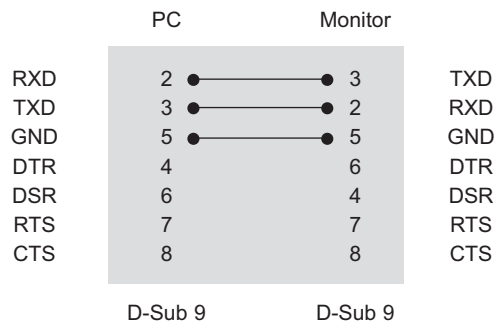



## Communication Parameters

- Baud rate: 9600 bps (UART)
- Data length: 8 bits
- Parity : None
- Stop bit: 1 bit
- Communication code: ASCII code
- Use a crossed (reverse) cable.

## Command reference list

	COMMAND1	COMMAND2	DATA (Hexadecimal)		COMMAND1	COMMAND2	DATA (Hexadecimal)
01. Power	k	a	00 to 01	19. Tile V Position	d	f	00 to 64
02. Input select	x	b	See p.48	20. Tile ID	d	i	01 to 79
03. Aspect Ratio	k	c	See p.48	21. Tile H Size	d	g	00 to 64
04. Screen Mute	k	d	See p.48	22. Tile V Size	d	h	00 to 64
05. Contrast	k	g	00 to 64	23. Natural Mode	d	j	00 to 01
06. Brightness	k	h	00 to 64	24. Picture Mode	d	x	01, 03
07. Color	k	i	00 to 64	25. Fan Fault Check	d	w	FF
08. Tint	k	j	00 to 64	26. Elapsed Time Return	d	l	FF
09. Sharpness	k	k	00 to 32	27. Temperature Value	d	n	FF
10. OSD Select	k	l	00 to 01	28. Power On Delay	f	h	00 to 64
11. Remote Control Lock	k	m	00 to 01	29. Language	f	i	00 to 0c
12. Color Temperature	x	u	00 to 64	30. Reset	f	k	00 to 02
13. ISM Method	j	p	See p.47	31. H Position	f	q	00 to 64
14. Energy Saving	j	q	00 to 01	32. V Position	f	r	00 to 64
15. Auto Configuration	j	u	01	33. H Size	f	s	00 to 64
16. Key	m	c	See p.50	34. Serial No.	f	y	FF
17. Tile Mode	d	d	See p.47	35. S/W Version	f	z	FF
18. Tile H Position	d	e	00 to 64				

### NOTE

- For Tile H Position, Tile V Position, Tile H Size, Tile V Size, H Position, V Position, H Size Command
  - The default value is Data 32H.
  - The allowed range differs depending on the input and resolution.
  - When the entered data is out of the allowed range (within 0H to 64H of the data range), an error occurs in ACK.

## Transmission / Receiving Protocol

### Transmission

[Command1][Command2][ ][Set ID][ ][Data][Cr]

[Command 1]	First command to control the set.(Z)
[Command 2]	Second command to control the set.
[Set ID]	Set ID wants to communicate with the multi vision Command for test is 00.
[Data]	The information passed to the multi vision
[Cr]	Carriage Return ASCII code '0x0D'
[ ]	ASCII code 'space (0x20)'

### OK Acknowledgement

[Command2][ ][Set ID][ ][OK][Data][x]

[Command 2]	Use as command
[Set ID]	Set ID of the multi vision which responded.
[Data]	Getting at multi vision.

### 01. Power (Command: k a)

- ▶ To control Power On/Off of the Multi Vision.

Transmission [k][a][ ][Set ID][ ][Data][Cr]

Data 00 : Power Off      01 : Power On

Ack [a][ ][Set ID][ ][OK/NG][Data][x]

\* In a like manner, if other functions transmit 'FF' data based on this format, Acknowledgement data feedback presents status about each function.

\* Note: In this model, Multi Vision will send the Acknowledge after power on processing completion.

There might be a time delay between command and acknowledge.

### 02. Input Select (Command: x b)

- ▶ To select input source for Multi Vision.

Transmission [x][b][ ][Set ID][ ][Data][Cr]

Data 20: AV  
60: RGB-PC  
C0: DP  
90: HDMI  
92: DVI-D

Ack [b][ ][Set ID][ ][OK/NG][Data][x]

### 03. Aspect Ratio (Command: k c)

- ▶ To adjust the screen format.

Transmission [k][c][ ][Set ID][ ][Data][Cr]

Data 01: 4:3  
02: 16:9  
09: Just scan

When Tile Mode and OSD Pivot are set to On, only the aspect ratio of 16:9 and JustScan are supported.

### 04. Screen Mute (Command: k d)

- ▶ To select screen mute on/off.

Transmission [k][d][ ][Set ID][ ][Data][Cr]

Data 00: Screen mute off (Picture on), Video-out Mute off  
01: Screen mute on (Picture off)  
10: Video-out Mute on

Ack [d][ ][Set ID][ ][OK/NG][Data][x]

\* In case of Video-out Mute on only, Multi Vision will display On Screen Display (OSD). But, in case of screen mute on, Multi Vision will not display On Screen Display (OSD).

**05. Contrast (Command: k g)**

- ▶ To adjust screen contrast.  
You can also adjust contrast in the PICTURE menu.

Transmission [k][g][ ][Set ID][ ][Data][Cr]

The data range is from 00 to 64(in Hex)  
\* Refer to 'Real data mapping'. See p.52.

Ack [g][ ][Set ID][ ][OK/NG][Data][x]

**06. Brightness (Command: k h)**

- ▶ To adjust screen brightness.  
You can also adjust brightness in the PICTURE menu.

Transmission [k][h][ ][Set ID][ ][Data][Cr]

The data range is from 00 to 64(in Hex)  
\* Refer to 'Real data mapping'. See p.52.

Ack [h][ ][Set ID][ ][OK/NG][Data][x]

**07. Color (Command: k i)**

- ▶ To adjust screen color.  
You can also adjust color in the PICTURE menu.

Transmission [k][i][ ][Set ID][ ][Data][Cr]

The data range is from 00 to 64(in Hex)  
\* Refer to 'Real data mapping'. See p.52.

Ack [i][ ][Set ID][ ][OK/NG][Data][x]

**08. Tint (Command: k j)**

- ▶ To adjust screen tint.  
You can also adjust tint in the PICTURE menu.

Transmission [k][j][ ][Set ID][ ][Data][Cr]

Data Red: 00 - Green: 64 (\*transmit by Hexadecimal code)

\* Refer to 'Real data mapping'. See p.52.

Ack [ j ][ ][Set ID][ ][OK/NG][Data][x]

**09. Sharpness (Command: k k)**

- ▶ To adjust screen sharpness.  
You can also adjust sharpness in the Picture menu.

Transmission [k][k][ ][Set ID][ ][Data][Cr]

The data range is from 00 to 32(in Hex)  
\* Refer to 'Real data mapping'. See p.52.

Ack [k][ ][Set ID][ ][OK/NG][Data][x]

**10. OSD Select (Command: k l)**

- ▶ To select OSD (On Screen Display) on/off.

Transmission [k][l][ ][Set ID][ ][Data][Cr]

Data 00: OSD off

01: OSD on

Ack [l][ ][Set ID][ ][OK/NG][Data][x]

**11. Remote Control Lock Mode (Command: k m)**

- ▶ To lock the remote control.

Transmission [k][m][ ][Set ID][ ][Data][Cr]

Data 00: Lock off

01: Lock on

Ack [m][ ][Set ID][ ][OK/NG][Data][x]

If you're not using the remote control controls on the Multi Vision, use this mode. When main power is on/off, remote control lock is released.

**12. Color Temperature (Command: x u)**

- ▶ To adjust color temperature.  
You can also adjust color temperature in the Picture menu.

Transmission [x][u][ ][Set ID][ ][Data][Cr]

The data range is from 00 to 64(in Hex)  
\* Refer to 'Real data mapping'. See p.52.

Ack [u][ ][Set ID][ ][OK/NG][Data][x]

**13. ISM Method (Command: j p)**

- ▶ To avoid having a fixed image remain on screen.

Transmission [ j ][p][ ][Set ID][ ][Data][Cr]

Data 04: White Wash  
08: Panel ISM On  
20: Color Wash  
88: Panel ISM Off

Ack [p][ ][Set ID][ ][OK/NG][Data][x]

**14. Energy Saving (Command: j q)**

- ▶ To control the energy saving function.

Transmission [ j ][q][ ][Set ID][ ][Data][Cr]

Data 00: Off  
01: On

Ack [q][ ][Set ID][ ][OK/NG][Data][x]

**15. Auto Configuration (Command: j u)**

- ▶ To adjust picture position and minimize image shaking automatically.  
Auto configuration only works in RGB-PC mode.

Transmission [ j ][u][ ][Set ID][ ][Data][Cr]

Data 01: To set

Ack [u][ ][Set ID][ ][OK/NG][Data][x]

**16. Key (Command: m c)**

- ▶ To send IR remote control code.

Transmission [m][c][ ][Set ID][ ][Data][Cr]

Ack [c][ ][Set ID][ ][OK/NG][Data][x]

**17. Tile Mode(Command : d d)**

- ▶ Change a Tile Mode.

Transmission [d][d][ ][Set ID][ ][Data][Cr]

Ack [d][ ][Set ID][ ][OK/NG][Data][x]

Data	Description
00 :	Tile mode is off
12 :	1 x 2 mode(row x column)
13 :	1 x 3 mode
14 :	1 x 4 mode
:	
bb :	11 x 11 mode

\* The maximum value changes depending on the installation method.

**18. Tile H Position(Command : d e)**

- ▶ To set the Horizontal position.

Transmission [d][e][ ][Set ID][ ][Data][Cr]

Data Min : 00H ~ Max : 64H

\* Refer to 'Real data mapping'. See p.52.

Ack [e][ ][Set ID][ ][OK/NG][Data][x]

**19. Tile V Position(Command : d f)**

- ▶ To set the Vertical position.

Transmission [d][f][ ][Set ID][ ][Data][Cr]

Data Min : 00H ~ Max : 64H

\* Refer to 'Real data mapping'. See p.52.

Ack [f][ ][Set ID][ ][OK/NG][Data][x]

**20. Tile ID (Command : d i)**

- ▶ To assign the Tile ID for Tiling function.

Transmission [d][i][ ][Set ID][ ][Data][x]

Data Min : 01H ~ Max : 79H

(Hexadecimal code)

Ack [i][ ][Set ID][ ][OK/NG][Data][x]

\* The maximum value changes depending on the installation method.

**21. Tile H Size(Command : d g)**

- ▶ To set the Horizontal size.

Transmission [d][g][ ][Set ID][ ][Data][Cr]

Data Min : 00H ~ Max : 64H

\* Refer to 'Real data mapping'. See p.52.

Ack [g][ ][Set ID][ ][OK/NG][Data][x]

**22. Tile V Size(Command : d h)**

- ▶ To set the Vertical size.

Transmission [d][h][ ][Set ID][ ][Data][Cr]

Data Min : 00H ~ Max : 64H

\* Refer to 'Real data mapping'. See p.52.

Ack [h][ ][Set ID][ ][OK/NG][Data][x]

**23. Natural Mode (In Tile mode) (Command : d j)**

- ▶ To assign the Tile Natural mode for Tiling function.

Transmission [d][j][ ][Set ID][ ][Data][Cr]

Data 0: Natural Off

1: Natural On

Ack [j][ ][Set ID][ ][OK/NG][Data][x]

**24. Picture Mode (Command : d x)**

- ▶ To adjust the picture mode.

Transmission [d][x][ ][Set ID][ ][Data][Cr]

Data 01: Standard

03: Studio

Ack [x][ ][Set ID][ ][OK/NG][Data][x]

**25. Fan Fault Check (Command : d w)**

- ▶ To check the Fan fault.

Transmission [d][w][ ][Set ID][ ][Data][Cr]

The data is always FF(in Hex).

Data ff: Read Status

Ack [w][ ][Set ID][ ][OK/NG][Data][x]

\* Data is the status value of the Fan fault.

Data 00: Fan fault

01: Fan OK

**26. Elapsed time return (Command : d l)**

- ▶ To read the panel used time.

Transmission [d][l][ ][Set ID][ ][Data][Cr]

The data is always FF(in Hex).

Ack [l][ ][Set ID][ ][OK/NG][Data][x]

The data means used hours

(Hexadecimal code)

**27. Temperature value (Command : d n)**

- ▶ To read the inside temperature value.

Transmission [d][n][ ][Set ID][ ][Data][Cr]

The data is always FF(in Hex).

Ack [n][ ][Set ID][ ][OK/NG][Data][x]

The data means temperature value

(Hexadecimal code)

**28. Power On Delay (Command : f h)**

- ▶ Set the schedule delay when the power is turned on (Unit: second)

Transmission [f][h][ ][Set ID][ ][Data][Cr]

The data range is from 00 to 64(in Hex)  
(\* 00H: Off)

\* Refer to 'Real data mapping'. See p.52.

Ack [h][ ][Set ID][ ][OK/NG][Data][x]

**\* Real data mapping**

00 :	Step 0
:	
A :	Step 10 (Set ID 10)
:	
F :	Step 15 (Set ID 15)
10 :	Step 16 (Set ID 16)
32 :	Step 50
64 :	Step 100
:	
6E :	Step 110
:	
73 :	Step 115
74 :	Step 116
:	
CF :	Step 199
:	
FE :	Step 254
FF :	Step 255

**29. Language (Command : f i)**

- ▶ Set the OSD language.

Transmission [f][i][ ][Set ID][ ][Data][Cr]

Data 0.	Korean	7.	Portuguese
1.	Chinese	8.	Spanish(EU)
2.	Japanese	9.	Arabic
3.	English	a.	Persian
4.	French	b.	Turkish
5.	German	c.	Russian
6.	Spanish (SCA)		

Ack [i][ ][Set ID][ ][OK/NG][Data][x]

**30. Reset (Command : f k)**

- ▶ Execute the Picture, Screen and Factory Reset functions.

Transmission [f][k][ ][Set ID][ ][Data][Cr]

Data 0 : Picture Reset  
1 : Screen Reset  
2 : Factory Reset

Ack [k][ ][Set ID][ ][OK/NG][Data][x]

**31. H Position (Command : f q)**

- ▶ To set the Horizontal position.

Transmission [f][q][ ][Set ID][ ][Data][Cr]

The data range is from 00 to 64(in Hex)  
\* Refer to 'Real data mapping'. See p.52.

Ack [q][ ][Set ID][ ][OK/NG][Data][x]

\* This function is only working in Tile Off Mode.

**32. V Position (Command : f r)**

- ▶ To set the Vertical Position.

Transmission [f][r][ ][Set ID][ ][Data][Cr]

The data range is from 00 to 64(in Hex)  
\* Refer to 'Real data mapping'. See p.52.

Ack [r][ ][Set ID][ ][OK/NG][Data][x]

\* This function is only working in Tile Off Mode.

**33. H Size (Command : f s)**

- ▶ To set the Horizontal size.

Transmission [f][s][ ][Set ID][ ][Data][Cr]

The data range is from 00 to 64(in Hex)  
\* Refer to 'Real data mapping'. See p.52.

Ack [s][ ][Set ID][ ][OK/NG][Data][x]

\* This function is only working in Tile Off Mode.

**34. Serial No.Check (Command : f y)**

- ▶ To read the serial numbers.

Transmission [f][y][ ][Set ID][ ][Data][Cr]

Data FF (to read the serial numbers)

Ack [y][ ][Set ID][ ][OK/NG][Data][x]

**35. S/W Version (Command : f z)**

- ▶ Check the software version.

Transmission [f][z][ ][Set ID][ ][Data][Cr]

Data FF (to read the S/W version)

Ack [z][ ][Set ID][ ][OK/NG][Data][x]

## 42" PDP Specification

PANEL		Operation	
Screen Size	42"	Operation Temperature	0°C ~ 40°C
Bezel / Seam size	0.9/1.8mm	Humidity	0~80%
Aspect Ratio	16 : 9	Altitude	2,000m
Native Resolution / Supported Resolution	1,024 x 768 (XGA) / 1,920 x 1,080P	Life Time	100,000hours
Brightness	1,700cd/m2 (without screen filter) 740cd/m2 (with screen filter)	<b>Power Input Condition</b>	
Contrast Ratio	1,000,000:1	Input Voltage	AC 100V to AC 240V
Viewing Angle [HxV]	179 x 179	Input Current	6.4A at AC 100V to 140V, 50/60Hz
Response Time	0.001ms	Normal Frequency	50/60Hz
Color Depth	10 bit / 1,073 billion color	<b>Physical Specification</b>	
Power Consumption Accumulated Power Consumption	Typical 360W Typical 133Wh	Dimension [WxHxD]	925.2(W) x 523(H) x 56(D)
<b>Connectivity</b>		Weight	18Kg
Daisy Chain	RS-232C In/Out	VESA Standard Mount Interface	400 x 300
	DVI In/Out	<b>Accessory</b>	
	HDMI In/DVI Out	Accessory	Remote Controller, Power cable, RGB Cable, DVI Cable, RS-232C Cable, Lan Cable, User Manual
Input	Composite In	Option Accessory	Wall mount bracket, Stand floor
	PC(D-Sub) In		



## MEMO

---